



The amplifier series is distributed with the CE mark, because they are in accordance with the European Directives on EMC and Low Voltage.

WARNING!
***ELECTRICAL AND CONTROL EQUIPMENT CAN BE
DANGEROUS IF HANDLED IMPROPERLY***

This manual describes the mechanical and electrical characteristics of the Microspeed series.

It is important, that the installation procedures are only performed by qualified personnel in accordance with local safety guidelines. Whoever installs the equipment must follow all of the technical instructions printed in this manual.

For more information, please contact AXOR'S technical department.

English

All rights reserved. Reproduction in whole or in part is prohibited without prior written consent of the copyright owner.

All specifications are subject to change without prior notice.



Index

1) <u>Description</u>	Pag
1.1 Introduction	3
1.2 Technical features	4
1.3 Inputs and outputs	5
1.4 Drive dimensions	6
2) <u>Adjustments</u>	
2.1 Personalizations and settings	6-7
2.2 Solder bridges	8
2.3 Potentiometer adjustments	9
3) <u>Diagnostic</u>	
3.1 L.E.D. indicators	10
4) <u>Installation</u>	
4.1 Power supply rating	11-13
4.2 EMC requirements	14-20
4.3 Connections	21-24
5) <u>Commissioning</u>	
5.1 Initial start up	25-26
6) <u>Setting up the drive</u>	
6.1 Speed adjustment with tacho feedback	26
6.2 Nominal current adjustment	27
6.3 Peak current adjustment	28
6.4 Offset adjustment	28
6.5 Ramp time adjustment	29
6.6 Adjustment with armature feedback	30-31
6.7 Dynamic constant adjustment	32-33
7) <u>Troubleshooting</u>	34
8) <u>Options</u>	
8.1 Available options	35
8.2 Encoder feedback	36-39
8.3 Limit switch	40-41
8.4 Pwm+Direction command	42-43
8.5 Block Diagram	44



1.1 Introduction

The Microspeed Servo Amplifier is a compact full DC four quadrant drive. The (MOSFET) output power stage is controlled by a 22 KHz PWM (Pulse With Modulation) signal that allows it drive small to medium sized brushed servo motors (up to 2Nm) where high dynamic performance and precise speed is required.

The Microspeed only requires a single power supply to operate and develops all needed voltages on board to make power supply design easy and convenient. The input voltage is from 12 to 130 Vdc max "See Technical Data". (Chapter 4 describes how to design a proper supply.) Closing the velocity feedback loop to motor may be done in several different ways to accommodate most applications. Three types of velocity feedback are available with these drives.

Feedback Types: Tachogenerator, Armature, Encoder(option), PWM+Dir (option)

Two inputs are present for the disabling of clockwise and counter-clockwise motor rotation (+LM SW,-LM SW.option)

The possibility to completely adjust the Dynamic Constant exists by inserting new values "as opposed to the standard mounted values".

The insertion of various prearranged operational drive values are easily realized by opening and closing solder points. The intervention of drive protections are all visible with LEDs on the front of the drive.

The nominal current, as well as peak current is adjusted through resistance on the base.

The operating temperature is from 0 to +40 °C (32° to 104°F). In accordance with the current size and model, supplemental ventilation can be requested.



1.2 Technical Data

MICROSPEED VOLTAGE

Microspeed 12	9 - 28 Vdc*
Microspeed 60	20 - 80 Vdc*
Microspeed 110	30 - 130 Vdc*

* Minimum and maximum voltage.
Nominal are: 12Vdc, 60Vdc, 100Vdc.

MICROSPEED CURRENT SIZES

Sizes	I Nom. (A)	I Peak (A)
1/2	+/- 1	+/- 2
2,5/5	+/- 2,5	+/- 5
6/12	+/- 6	+/- 12
10/20	+/- 10	+/- 20

TECHNICAL DATA CHARACTERISTICS

--PWM frequency	22Khz
--Operating Temperature	32°-104°F (0°+40°C)
--Storage Temperature	12°-158°F (-10°+70°C)
--Drift	+/-5 uV Degree F
--Analog inputs	+/-10Vdc
--Current Monitor (Imot)	+/-7,5Vdc = (PK. curr.)
--Auxiliary power supply	+/-10Vdc (4mA Max.)
--Band Width Current	2.5Khz
--Weight	12.69oz (360 gr.)
--Humidity	10/95% not-condensing



1.3 Inputs and Outputs

Power terminals

- +AT Power supply input positive pow. supply
- AT Power supply input negative pow. supply
- +M Positive motor terminal
- M Negative motor terminal

Signal terminals

The Following are descriptions of the output drive connector.

- 1 Drive OK NC (open collector max current 100mA)
- 2 Demand current
- 3 Common zero signal
- 4 Auxiliary output voltage +10 volts 4 mA max
- 5 Auxiliary output voltage -10 volts 4 mA max
- 6 Enable(+ 10/30 volt drive enabled)
- 7 Input speed reference + (Non inverting input)
- 8 Input speed reference -(inverting input)
- 9 Tacho input +
- 10 Tacho input -



1.4 Drive dimensions

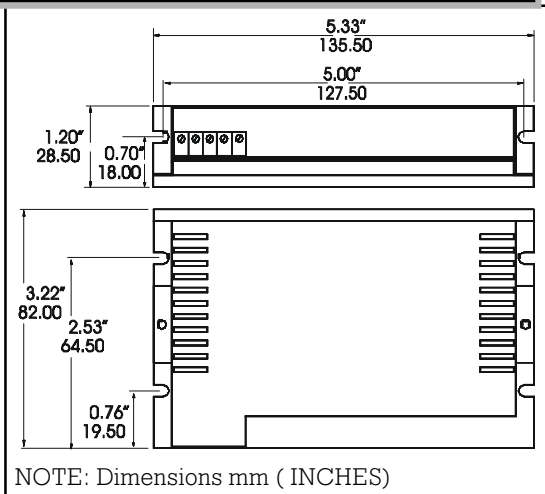

2.1 Personalizations and setting

WARNING : After switching off to do the adjustments, please wait for about 30 sec before working inside the drive.

If the drive isn't adjusted with the proper servomotor, follow these procedures.

All of the personalizations are located inside of the Microspeed .

-To enter to the adjustment components and the solder bridges , unscrew (10) , and remove the cover (11).

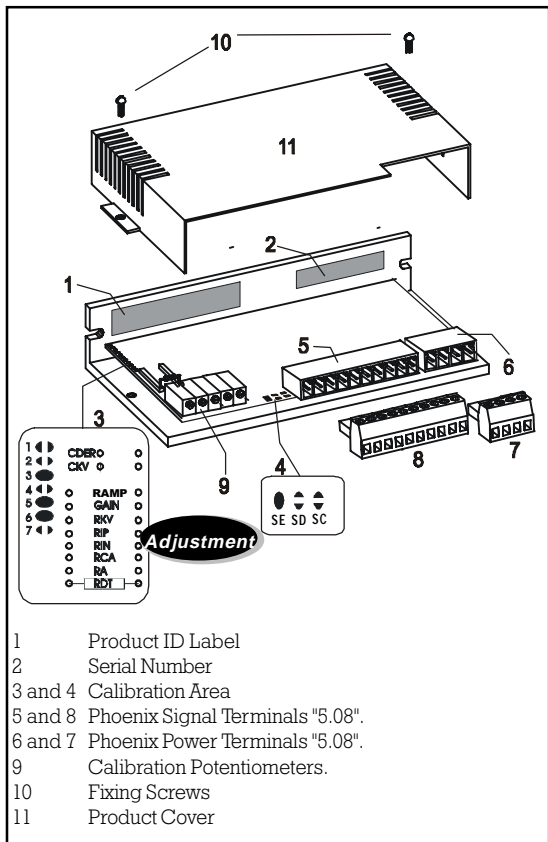

Continue



All of the adjustments are located in the area behind the potentiometers. It's there that a socket containing all of the adjustment components is located..

The socket is made by a double row of components with pitch 7.62mm/0.3" (resistors) with 8+8 ways, and 2+2 ways for components with pitch 5.08 mm/0.2" (capacitors).

The resistors may be 1/4W.

(RDT)

(RA)

(RCA)

(RIN)

(RIP)

(RKV)

(GAIN)

(RAMP)

(pitch 5,08) (CKV)

(pitch 5,08) (CDER)

2.2 Solder bridges

J1 Normally open. If closed, the activation of IN protection, inhibits the output of the drive's OK transistor. When this situation occurs the green OK LED is OFF.

J2 -J4 Normally opens. (See chapter 6.5 "Ramp time adjustment").

J3 Normally closed. (See chapter 6.5 "Ramp time adjustment").

J5 -J6 Normally closed. If open, the dynamic constant CKR and RKV must be inserted on the personalization socket.(PI loop gain).

J7 Normally open. If closed, enable the armature feedback (See chapter 6.6)

Note:For the adjustments SC,SD,SE solder Bridges, see page 40,42.



2.3 Potentiometer adjustment

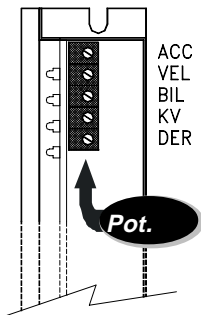

ACC

The solder bridges J2-J4 allow insertion of the acc/dec function (ramp). With this potentiometer we can adjust the slope of the ramp in acceleration and deceleration. Turning the potentiometer clockwise (cw) increases the ramp time from 0,1 to 1 Sec (with 10 V reference).

It is also possible to increase more, this time by opening solder bridge J3 and inserting resistance RAMP on the socket. (See chapter ADJUSTMENT)

VEL

Speed potentiometer. Turn the potentiometer clockwise (cw) to increase the maximum speed and anti-clockwise (ccw) to reduce the maximum speed.

The range of the adjustment is $\pm 20\%$.

BIL

Offset adjustment. Adjust this potentiometer to cancel any offset in the external speed ref. signal.

(Max ref. compensation $\pm 200\text{mV}$).

KV

With this adjustment we can improve the dynamic behaviour of the servomotor. With a clockwise turn (cw) we increase the gain of the PI "speed stage", therefore, improving the response.

DER

Turn the potentiometer clockwise (cw) to increase the derivative effect, reducing the amount of overshoot in the system response.



3.1 LED indicators

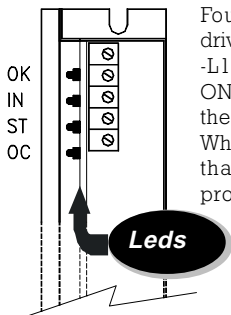

Four LEDs are available on the drive and they signify the following:
-L1 (GREEN) OK Normally ON, signifying proper operation of the drive.

When the LED is OFF, it indicates that at least one of the drive protection functions is active.

-L2 (RED) IN Normally OFF, it is lit when it exceeds the programmed value.
(Reversible alarm)

-L3 (RED) ST Normally OFF, it represents overheating of the heatsink drive. This fault provokes the activation and memorization of the alarm. To reset it is necessary that you turn off the power supply, wait until the heatsink temperature is lower, and then restart the power supply.

-L4 (RED) OC Normally OFF. May come ON, because of a short circuit between motor terminals or come to ground. It can't be reset and the fault provokes the memorization of the alarm. Switch off the system, eliminate the cause and then restart the power supply.



4.1 Power supply rating

WARNING: Use the following scheme and equation shown below to calculate the power supply rating.

The drive doesn't need auxiliary voltage, all of the voltages requested come from an internal flyback.

A single or three phase transformer may be able to supply one or more drives.

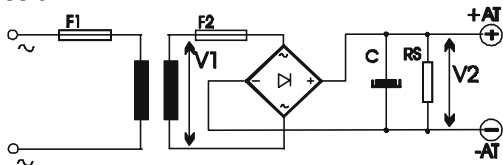

Trasformer



The drive has the internal zero signal connected with the negative (power), consequently **Don't use auto transformers.**

The factory recommends using transformers with the secondary winding that must be delta/triangle-connected.

VOLTAGE: The primary voltage depends on the available net voltage. The secondary voltage will be calculated according to the motor's characteristics and according to the voltage drive range.

The value will be:

$$V1(ac) = \frac{V_{motor}}{0,9 \times 1,36}$$



Power supply rating (continued)

The factory suggests keeping a margin by choosing AC voltage to avoid too high voltage during the deceleration phases of the motor; this value is 60 VDC (44 VAC)

Max value is 80Vdc and minimum value is 22 Vdc.

The power rating of the transformer is calculated in accordance with the total power (SUM) of all single motors used:

$P(\text{VA}) = \text{Power absorbed servomotor 1} + \text{power abs. servomotor 2} + \dots \text{etc}$

Notice: If multiaxis application is required, the transformer power rating may be reduced by 30 % respecting the original equation.

REF. the filter capacitor - the factory recommends one with a working voltage of at least 100 Vdc.

The appropriate value may be found with the following equation:

$$C \text{ (mF)} = \frac{P \text{ (VA) trasfo.} \times 2000}{V^2}$$

V^2 = DC voltage on the terminals capacitor without load.

The capacitor serves to filter the voltage from the bridge and recover the energy during the motors deceleration phases.



Power supply rating (continued)

Fusibili

A fuse should be fitted into each of the transformer's primary and secondary windings, F1 and F2.

These fuses may be replaced with a magneto-thermic switch with the same value.

The F1 fuse mounted on the primary protects the transformer.

This fuse must be the "slow" type.

The F2 fuse mounted on the secondary also protects the transformer and that fuse must be the "slow" type.

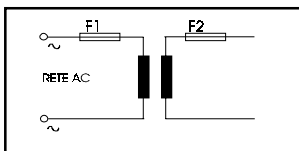

$$F 1^{\circ} = \frac{P \text{ (VA) transf.}}{V \text{ (primary) ac}} \times 1,1$$

F2	X MCS 1/2	= 2A
	X MCS 2,5/5	= 5A
	X MCS 6/12	= 10A
	X MCS 10/20	= 20A



4.2 Instructions for EMC Requirements

The regulated standard in accordance with conformity of electromagnetic is summarized in Regulation CEI EN 61800 (complete).

Microspeed conformity is assured only if it is installed following the precise assembly criteria expressed below. The fundamental assembly characteristics are summarized below:

- Use of appropriate network to filter the line (transformer input), from disturbances conducted or produced by the drive.

A series of filters released by AXOR are available for this purpose.

- Use of shielded cables, both for power connection (to the transformer and the motor), and for signal connection (also to the controller).

- Using the division of cables technique. Separate power cables from signal cables.

- The correct ground connection of predisposed parts.

- It is important that the drive's ground connections are as short as possible and no longer than 8 inches (20 cm). The figure shows the connection using terminals fixed to the drive's base (bottom). This connection also reduces disturbances in the net.

- The Motor ground cable has to be external (not inserted in a multipolar cable) with minimum section 1.5 mm² (0,059 square inch).



MASSA QUADRO /
GROUND PLANE



WARNING

L MAX = 20cm (8 inch)

4cm max

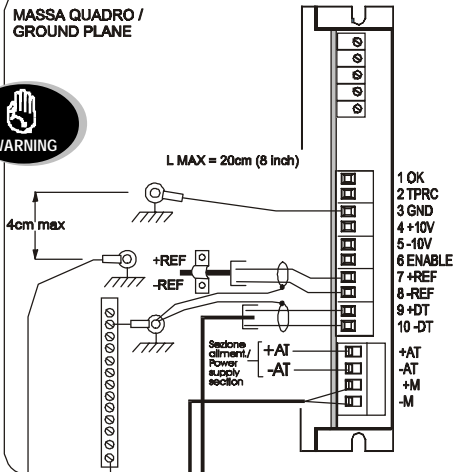

TERRA/EARTH

B A

CAVO DI MASSA
MOTORE /
MOTOR GROUND
CABLE

Collegare la massa
alla carcassa del motore /
Connect ground to
the body of the motor

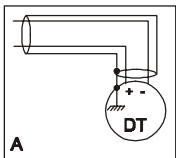
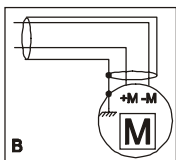



Filters

Of all of the mentioned system, the use of network filters is without a doubt fundamental in soppressing disturbances. Axor, after tests, has recognized some good solutions, about its products.

Concerning equipment where are mounted other sources, Axor can't evaluate the global equipment. In the following page, are reported some fundamental configurations, with the suggested filters.

We did an agreement with Schaffner and Timonta products. The market offers other product with the same characteristics, but not yet checked from Axor.

When other products will be checked and approved, it will be notified.

Follow reported an example about the noise level with and without filter as explained in the following pages.

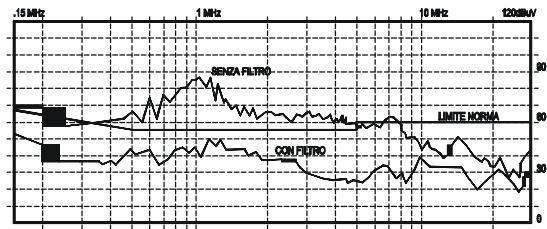



The recommended filters for the product lines in some of the main configurations are shown in the table on page 34-35. These filters are produced by SCHAFFNER and TIMONTA.

Other products with the same characteristics may be sufficient, but have not been tested or evaluated by AXOR.

In choosing the filter, we also considered the current absorption of its connecting devices. AXOR recommends connecting the filter before the power supply transformer. This method, besides offering better disturbance suppression result, also allows for the use of filters capable of supporting a lot less current, consequently they're cheaper (takes advantage of the transformer's ratio).

Follow the formula below for the filter dimensions to be used with the MicroB.

$$I(A) = \frac{P \text{ tot}}{1.73 \times V \text{ primary}}$$

Where:

I= is the nominal current in Amperes for the necessary filter.

V_{primary}= is the voltage of Transformer.

P_{tot}= is the motor's max. power absorption in watts(VA)

P_{tot}=VA= Motor power₁ + motor power₂ + ...ect.



EMC requirements

For filter connection (divert to building ground the unwanted frequency) considering such devices can produce small leakage current towards building ground (this current amounts to "some" of milliamperes). For these precautionary reasons, it is necessary to connect the filter to building ground prior to connecting the power supply. Regarding current leakage, remember that it must be considered when sizing differential devices, thus avoiding undesired interventions. The precise data relative to our filters can be found below.

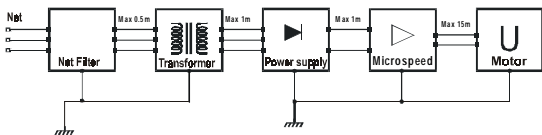

- As shown, the filter must be placed before the transformer.
- All connections of the Net filters must be shielded and shouldn't be longer than the length shown in the scheme.
- The cable shield must cover the entire length of the wire and be as close as possible to the connection terminals.
- Always use shielded cable (twisted) to connect the motor and the drive.
- Avoid passing signal and power cables through the same channels.
- It is very important that the panel where the filters are mounted is connected to ground.
- Power and Command/Signal conductors should not be placed in the same channels (keep separate). Avoid twisting, crossing, etc. If crossing is inevitable, try to cross at a 90 degree angle. Where possible use metallic channels connected to ground.



Filters

Electrical Characteristics

Below is a table showing the electrical characteristics of our recommended filters. Pay particular attention to leakage, differential adjustments, and nominal current in accordance with operational temperature.

Type	Current (A)	Leakage Curr. (mA)	Power loss W	Weight Lb.
SCHAFFNER FN355	3(40°C)	0.07 (400V 50Hz)	1.5	0.55
SCHAFFNER FN2070	3(40°C)	0.4 (250V 50/60Hz)		0.55
TIMONTA FMW4	4(40°C)	<0.5 (400V 50/60Hz)	1	0.6
TIMONTA FSS2	3(40°C)	<0.5 (250V 50/60Hz)		0.6
TIMONTA FSS2	6(40°C)	<3 (250V 50/60Hz)		0.6

Mechanical dimension

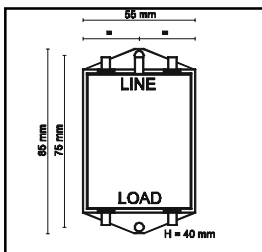



Filters

The TIMONTA FMW65-4: 3 PHASE Series filters are furnished with Fast-on connectors for both input and output.

Max. voltage : 440Vac

Max. current : 4A @ 40°C

The SCHAFFNER FN355-3: 3 PHASE Series filters are furnished with Fast-on connectors for both input and output.

Max. voltage : 420Vac

Max. current : 3A @ 40°C

Working temperature: -25° +85°C

The TIMONTA FSS2-65-3 TIMONTA FSS2-65-6

: Single PHASE Series filters are furnished with Fast-on connectors for both input and output.

Max. voltage : 250Vac

Max. current : 3A @ 40°C,

Max. current : 6A @ 40°C

The SCHAFFNER FN2070-3: Single PHASE Series filters are furnished with Fast-on connectors for both input and output.

Max. voltage : 250Vac

Max. current : 3A @ 40°C

Working temperature: -25° +85°C



4.3 Connections

Below is information about appropriate wiring; thereby, improving noise reduction and safety.

-Always use shielded cables to connect the ref signals and the tacho signal.

-Signal cables and power cables must be segregated and wired through different trunking.

-Reference the section of the cable, the factory suggests:

1.5 mm/square up to size 6/12 for power cables.

2.5 mm/square up to size 10/20 for power cables.

Power connection

D) The outputs +M and -M may be connected directly to the motor terminals.

When a motor has an inductance value less than 0,7 - 0,8 mH, a choke is required, connect in series, so the form factor is improved.

This avoids overheating the servomotor.



Connections

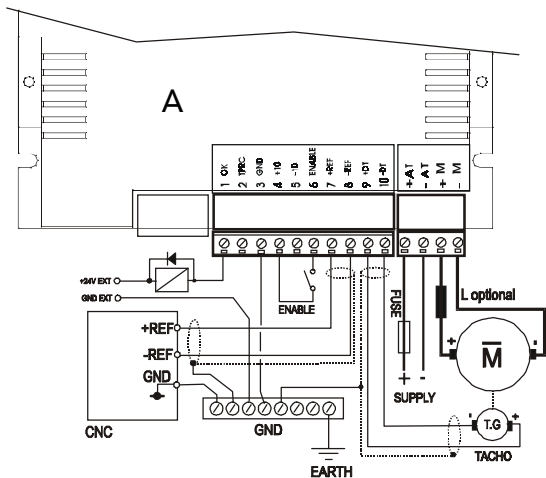

A) This drawing shows an example with an application to connect the differential speed ref from CNC.



Connections

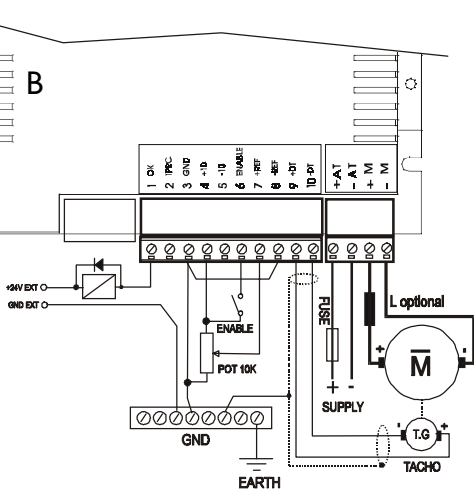

B) This drawing shows an example of connecting the speed reference using the internal voltage of the drive. The speed potentiometer must have a value between 10k and 47 k.

The tacho screen must be connected to 0 S of the drive with only one cable. That cable connects the tacho screen to the isolated bar in the electrical box.



Connection

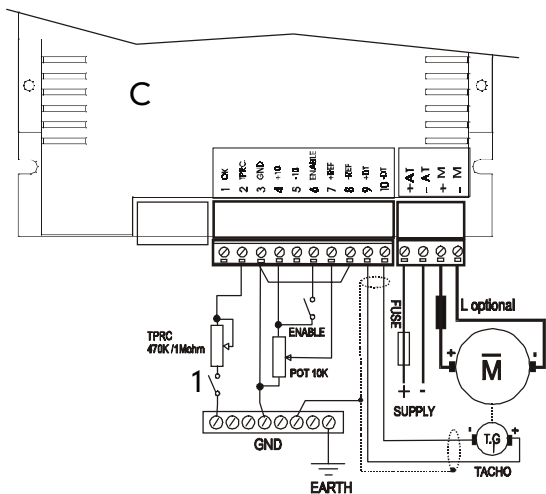

C) Applying a resistive load a current limitation comes from the drive, when contact 1 is closed.

If we insert a potentiometer with a value of 470 Kohm connected as rheostat, the current may be reduced from 95% to zero.



5.1 Initial start up

1)First, it is important that the motor's shaft is free from the load and be ready to stop the main power supply quickly, if necessary.

It is also important that the motor is fixed to a proper stand.

Please ensure that the ref signal is zero (0).

2)Apply power to the drive.

In normal situations,after a delay of about 1 second,the green OK LED will come on.

The motor must be still. (If the LED doesn't come on ,please check the proper value of the power supply with a multimeter).

WARNING: If the motor is driven by C.N.C., use the ref in manual mode with the servo error disabled.

(Space loop disabled).

3)Enable the drive; PWM ON active.

A good rule is to provide the enable after the power supply .

Check that the motor is stationary or turns slowly due to a signal offset,this means that the tacho polarity is correct. If the motor rotates in an opposite direction to the expected one,switch off and reverse the motor and tachogenerator connections .

WARNING: After switching off,wait about 15 seconds before re-applying power to the drive in order to avoid problems.

4)Increase the speed reference up to one(1) volt and check the sense of the motor's rotation. (If the motor rotates in the opposite direction of the expected one,reverse the motor and tachogenerator connections or reverse the speed reference connections).

continue



Start up (continued)

5) Apply the load to the motor's shaft, and insert the space loop on the C.N.C.

If the system's behaviour is the same as before and the servo error alarm doesn't appear, the system has been properly regulated.

6) Now, leave the system powered up in typical working conditions.

Check that no protection occurs (red LEDs all OFF), and the green drive LED is on.

6.0 Setting up the drive

6.1 Speed Adj. with tacho feedback

The drives are provided with the RDT resistance mounted on board. The drive is adjusted for 3000 rpm with a tachometer constant 10v/1000 rpm referred to 10V reference. If you desire to change this resistor, just open the cover of the drive, then change the value of the resistor.

To calculate it, please use the following equation:

$$\text{RDT (Kohm)} = \frac{\text{Kdt} \times n \times 9,7}{1000 \times \text{Vref}} - 8$$



Where:

Rdt is the value expressed in Kohm with a power rating of 1/8 or 1/4w.

Kdt is the tachogenerator constant

n° is the max speed expressed in RPM.

Vref is the max voltage reference expressed in Volts.

When the RDT resistor is mounted adjust the fine speed by using the VEL potentiometer located in front of the drive.

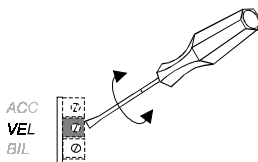

Clockwise.....Increases the speed.

CounterClockwise..Decreases the speed.

The range adjustments are +/- 20 %.

6.2 Nominal current adjustment

The drive is pre-set for nominal sized current, (R IN free). To reduce this value in accordance with the servomotor's characteristics it is necessary to mount a resistance R IN in the socket (see fig. 1).

A table with the correspondence current/resistor is reported below. current express in (A).

RIN Value in Kohm	*	18	8.2	4.7	3.3	2.2	1.8	1.2	1	0.82
MCS 1/2	1	0.9	0.8	0.7	0.65	0.6	0.55	0.5	0.45	0.4
MCS 2.5/5	2.5	2.3	2.1	1.9	1.8	1.5	1.4	1.2	1.1	1
MCS 6/12	6	5.5	5.1	4.6	4.2	3.7	3.4	2.9	2.7	2.4
MCS 10/20	10	9.3	8.5	7.7	7.1	6.2	5.8	5	4.6	4.2



6.3 Peak current adjustment

To reduce the value of peak current, it's necessary to mount RIP on the socket (see fig. 1) located inside of the drive.

Below is a table with the proper values:
current express in (A).

RIP Value in Kohm	*	220	150	82	68	56	47	39	33	22
MCS 1/2 (A)	2	1.9	1.8	1.65	1.6	1.5	1.4	1.35	1.3	1
MCS 2.5/5 (A)	5	4.6	4.5	4.1	3.9	3.7	3.5	3.4	3.1	2.6
MCS 6/12 (A)	12	11.1	10.7	9.7	9.3	8.9	8.4	8	7.5	6
MCS 10/20 (A)	20	18	17.4	15.5	15	14.4	13.7	13	12.1	10

6.4 Offset adjustment

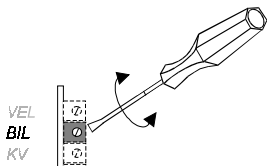

The drive is provided with the offset adjustment made by tachogenerator feedback.

If any further adjustment is required, please use the **Bil** potentiometer .

(The compensation is $\pm 200\text{mV}$ in respect to the input reference).

With zero input reference adjust the potentiometer until the motor is perfectly still.



6.5 Ramp time adjustment

This function is enabled by solder bridges **J2** , **J4** (closed). It allows adjustment of the ramp slope during both acceleration and deceleration.

Adjusting the ACC potentiometer, located in front of the drive, clockwise (cw) increases the ramp time between 0,1 and 1S (It corresponds to 10V reference). (See note 1)

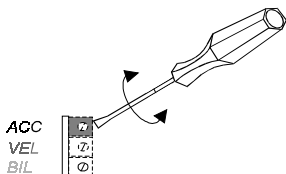

①

J3	J2	J4	FUNCTION	FUNCTION	NOTE
Closed	open	open	Ramp disabled	0 Sec.	Standard
Closed	closed	closed	Rampenable	0,1 - 1sec	ByACC
Open	closed	closed	Rampenable	RAMP	ByACC

It is also possible to modify the "range of the ramp" opening solder bridge **J3** and mounting a resistor in the socket between pin 8 and 17 (**RAMP res.**).

The proper value is reported on the table below.
(See note 2)

②

Res. RAMP	680K	820K	1MOHM
TIME (Sec.)	0,2-2,6	0,3-3,2	0,4-3,9



6.6 Armature feedback adjustment

Armature feedback mode may be used as speed feedback when a tachogenerator is not fitted to the motor.

Speed control is then less precise (the regulation range is 1/20, and below this value the torque is reduced).

This function will be enabled by solder bridge (closed) JP7 and mounting in the socket RA and RCA resistors.

RA resistor It will be mounted on the socket " pin 2-23" to adapt the system to the voltage motor constant.

To calculate it use this equation:

MCS60

$$R_{A(k\ ohm)} = 166 * \frac{V_{ref}}{E - 1,4 * V_{ref}}$$

MCS110

$$R_{A(k\ ohm)} = 159 * \frac{V_{ref}}{E - 3 * V_{ref}}$$

WHERE:

$$E = \frac{n * K_e}{1000}$$

K_e = Servomotor BEMF at 1000 rpm

V_{ref} = Max voltage reference.

n = max speed express in rpm.

Example: Servomotor with $K_e=20$ $n=3000$ RPM

$V_{ref}=10$ For MCS60.

$$E = \frac{3000 * 20}{1000} = 60$$

$$R_{A(kohm)} = 166 * \frac{10}{60 - 1,4 * 10} = 36 \text{ Kohm}$$

Use the nearest commercial value, 33 Kohm.



RCA resistor It will be mounted on the socket "pin 3-22", to compensate for the voltage drop due to the motor's internal resistance.

To calculate it, use this equation:

$$RCA \text{ (k ohm)} = 0,5 \times \frac{n \text{ Ke}}{V_{ref} I_{pk} R_i}$$

WHERE:

n = max. speed expressed in rpm.

R_i = Total motor resistance with brushes.

I_{pk} = Peak current, (size) of the drive.

K_e = Sevomotor BEMF at 1000 rpm.

V_{ref} = Max voltage reference.

Example: Drive 10/20 A , $R_i = 2.5$ ohm

$$RCA \text{ (kohm)} = 0,5 \times \frac{4000 \times 50}{10 \times 20 \times 2.5} = 200 \text{ Kohm}$$

Use a resistor of 56 Kohm or the higher value.

If, after this procedure the motor is unstable increase the value by using the next (higher) commercial value available.



6.7 Dynamic constant adjustment

Usually, these calibrations are made by the factory and don't need adjusting.

Only re-tuning by KV and DER potentiometer is required.

If high inertia loads are present (ratio 3:1 between load and motor), it is necessary to modify the proportional gain by "KV potentiometer" and increase the value of derivative by "DER potentiometer".

The adjustment procedure must take place with the load connected to the motor.

Connect a function generator with square wave (0,5 Hz +/- 1V) to the input speed reference terminals.

Connect the probe of the memory oscilloscope "channel A" to the tachogenerator signal. (The ground of the probe must be connected to the GND of the drive).

Adjust counter-clockwise (ccw) the "DER potentiometer".

Be sure that the load's motion doesn't create a safety risk.

Apply power to the drive and start it.

The load will begin to move alternatively; if possible increase the generator amplitude up to +/- 2V.

Check the signals in the oscilloscope; the waveforms should be as shown on the right.

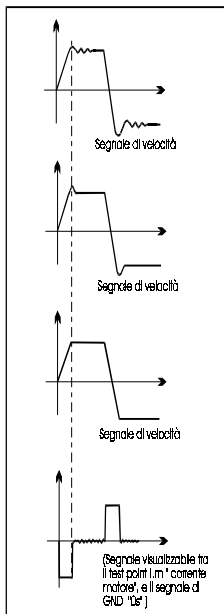

Insufficient proportional gain.

Increase the gain turning clockwise (cw) using **"KV potentiometer"** until achieving a situation as shown on the left.

To reduce the overshoot adjust clockwise (cw) using **"Der potentiometer"**, until achieving a situation as shown on the left.

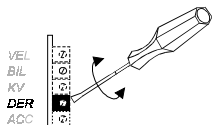
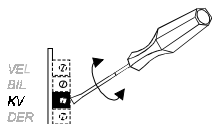

Caution: Don't exaggerate with the gain: it can cause unnecessary motor heating.

It's possible to increase the velocity loop derivative constant by inserting a capacitor CDER on the personalization adjustment. See chapter 2.1



7.0 Troubleshooting

- 1) Applying power supply the green OK LED is unlit.
 - Power supply voltage is out of range; Check the voltage value by instrument .

- 2) Green OK LED on with drive on and motor not moving..
 - Check the input signal.

- 3) When the drive is turned on the Green OK LED goes off and the red O.C. LED comes on..
 - Look for a short circuit between the motor terminals or the motor winding is connected to ground.
 - Switch off the system and check by instrument the insulation .

- 4) During the motor's deceleration phase,the green OK LED switch goes off
 - The voltage has exceeded the max value accepted.
 - Check the value of the filter capacitor .
 - See the chapter on power supply.

- 5) During normal operation the S.T. red LED is on and the motor stops.
 - Environment temperature too high "more than 40 °C(0°F)"
 - Ventilate " if necessary "





8.1 Options available

The speed feedback present on the Microspeed are highlighted.

Speed feedback from Encoder	◇
Speed feedback from Armature	●
Speed feedback from Tachogenerator	●
Command (Pwm + Dir)	◇
Current reference (torque mode)	●
Limit Switch	◇
External Power supply	◇

● = Standard

◇ = Optional

Options

Encoder feedback board
Single phase bridge 35A-600V
Three phase bridge 35A-600V
Filter capacitor (4700-10000uF), (100V-200V)
Single phase transformer
Three phase transformer
External choke
E.M.C Filter
etc.

External choke

When a motor has an inductance value less than 0,7 - 0,8 mH, it is necessary to use an external choke connected in series. Thereby improving the form factor and avoiding overheating the motor.

N.B. The two cables between the drive and the choke are a source of noise, consequently they should be kept as short as possible.



8.2 Encoder feedback (option)

The encoder feedback board (5.002.0) is an option of the MICROSPEED drive.

This card allows you to adjust the motor speed, using a signal coming from an encoder with two channels.

This solution saves the use of a tachogenerator, using the same signal requested for the position control.

The performance of the drive at low speeds are improved with the high encoder resolution.

It is recommended that you use an encoder with resolution of at least 500 imp/rev.

An auxiliary power supply +5 V or +12 V is available to supply the encoder.

Don't exceed the load declared.

If the encoder's absorption is unknown, please check it by a milliamperometer connected in series to +Vs.

If the value is higher, please use an external power supply.

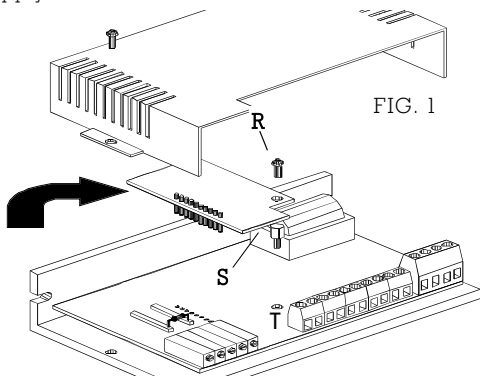



To insert the encoder board into the MICROSPEED, follow these procedures:

- Take off the cover and remove the R screw.
 - Insert the S stand-off in the R hole.
 - Mount the encoder card (5.002.0) inserting the pin strip into the Microspeed.
 - Now,replace the R screw and affix the card.
- If not specified,the Microspeed with encoder feedback is supplied adjusted to 25Khz.

Technical specification

<u>Encoder inputs</u>	Push-Pull ,Line-driver, Open-C.
<u>Power supply levels</u>	From 0V to 5 min. 0V to 24V max.
<u>Max. frequency</u>	200 Khz
<u>Encoder power supply</u>	S2 Close Vs=5V Max 75 mA S2 Open Vs= 12V Max.90 mA
<u>Operating temperature</u>	0 - 40 C°

Terminals description

<u>Code</u>	<u>Description</u>	<u>Pin out</u>
+Vs	Encoder power supply +5/12V	Output
GND	GND Power supply	Output
CHA	Input channel A encoder	Input
CHB	Input channel B encoder	Input

Solder bridge description

<u>Code</u>	<u>Description</u>	<u>Standard</u>
S1	Insert internal res. pull-up	Open
S2	Select value Power supply	Close
S3	Insert internal res. pull-up	Open



Encoder adjustment

The R10 resistor allows adjusting the speed with 10V of reference, to the preferred frequency.

$$R10 = \frac{680000}{F_{enc.}} \quad \text{Where } F_{enc.} \text{ is: } F_{enc.} = \frac{Imp.g \times Rpm}{60}$$

Example: N° encoder rev = 500 RPM = 3000

$$R10 = \frac{680000}{25000} = 27.2Kohm \quad \text{Will be use } 27Kohm$$

Connections

The system show in FIG. 2 is a typical connection with a push pull or open collector encoder.

The power supply is provided onboard by the same card.

If a Line driver encoder is used, connect to input channels, only CHA and CHB positive .

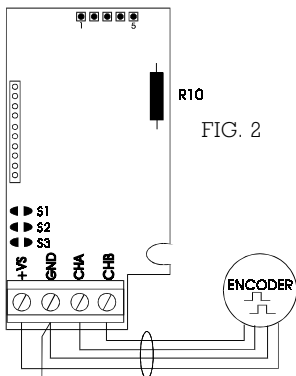



Below is an example, with push pull or open collector encoder. (Fig. 3).

The encoder receives the power supply from an external source, connecting the GND of the source with GND of the board.

If a Line driver encoder is used, connect to input channel only CHA and CHB positive.

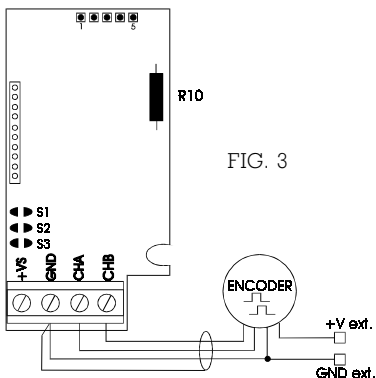



8.3 Limit switch input (option)

It's possible to enable clockwise (CW) and counter-clockwise (CCW) motor rotation by connecting the +LM SW and -LM SW inputs.

They may be used to block motor rotation when the machines overflow contact is intercepted.



Note - When one of these said contacts is intercepted the motor stops with the required inertia.

The Enable input in regards to this input always has priority.

To enable such a function, you must:

- Open soldering point SE
- Then connect on said input a positive voltage (between +5Vdc and + 24Vdc) coming from -for example two N.C. contacts. You may connect an external supply "combining negative" as well as from one of the supplies furnished on the Microspeed.

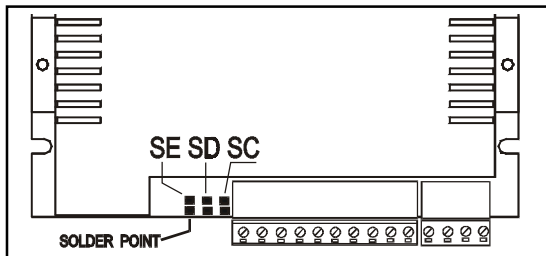
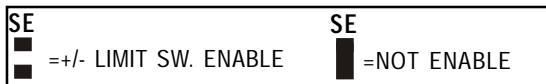



Input and output M3 connector (option)

- 1 Input limit switch-
- 2 Input limit switch+
- 3 Test point tachogenerator signal (+/-8V)
- 4 Common zero signal GND
- 5 Output current monitor (+/-7,5V=I pk)
- 6 N.C.

Example of Limit Switch connection

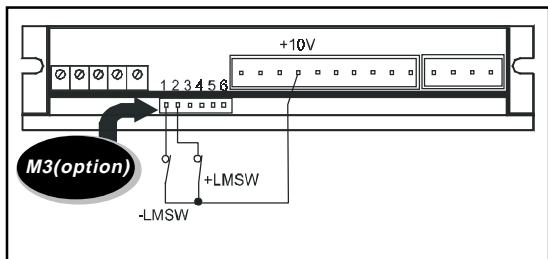

The following figure shows an application with external limit switch connections, using an internal power supply +10V.

Function: At opening one of the following contacts you disable the motor rotation in the corresponding direction.



8.4 Command with Pwm+Dir. (option)

It is possible to run the Microspeed using digital PWM commands. (Frequency signal in PWM plus direction signal DIR) (see figure).

Such logic signals must be furnished to the Microspeed by a controller **which must be able to elaborate the motor's speed ring** and possibly the positioning ring.

(The signals high logic level PWM and DIR must be between +5Vdc and 24Vdc max.).

The Microb comes predisposed to function with supported logic signals, also highlighted in the figure below.

--With High PWM logic signal and any DIR logic value you have zero output voltage between +M and -M. (Motor output terminal).

--With logic signal PWM = Low and DIR = Low you receive clockwise motor rotation.

--With logic signal PWM = Low and DIR = High you receive counter-clockwise motor rotation.

Signal connector description

- | | |
|------|--|
| 1 | Drive OK, Open Collector output 100mA Max. (Normally closed, opens when in protection mode). |
| 3-12 | GND Common zero signal |
| 4 | Auxiliary output voltage +10V, 4mA. |
| 5 | Auxiliary output voltage -10V, 4mA. |
| 6 | Enable (+10/30 Volt drive enabled) |
| 7 | PWM input Frequency |
| 8 | DIR input Direction |

Note: The other pins connector are N.C
For the leds indicator, in this option, see Chapter 3.1
The only active adjustments in this option are RIN and RIP.

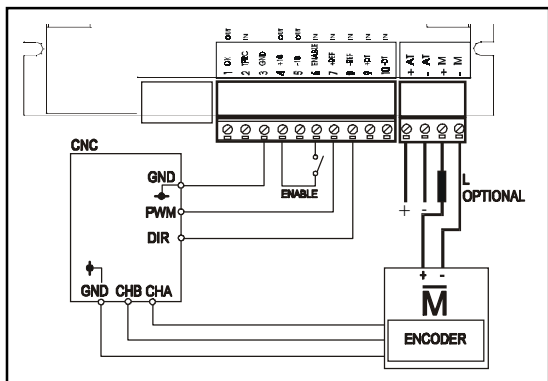
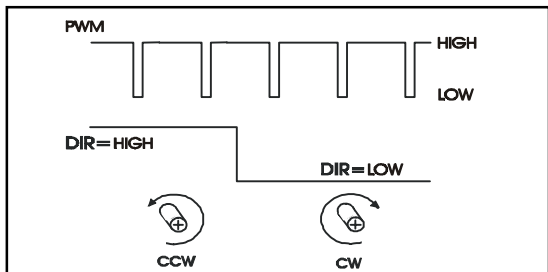

Note:

On Pwm+Direction Product cover, the +REF, -REF identifications correspond to, PWM and DIR inputs.

-- At Soldering point SC insert a pull-up resistor of 3,3 Kohm to internal +Vcc (+ 14V) for PWM input "Terminal 7".

-- At Soldering point SD insert a pull-up resistor of 3,3 Kohm to internal +Vcc (+ 14V) for DIR input "Terminal 8". See also figure pag.40



8.5 Block diagram

